







Part List





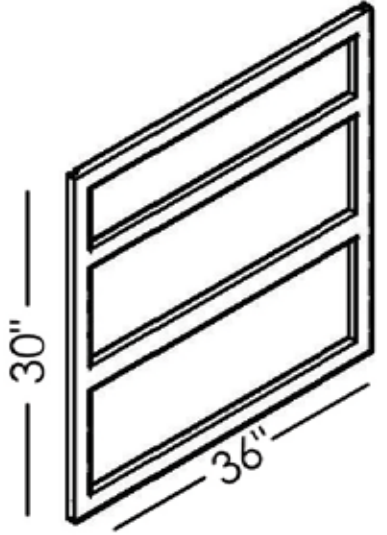
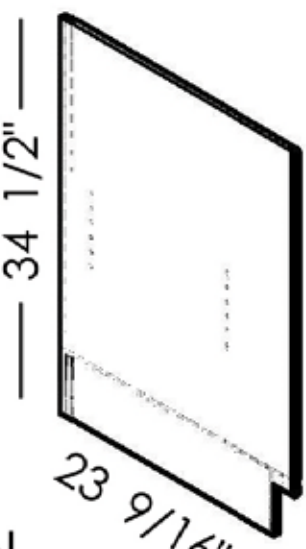
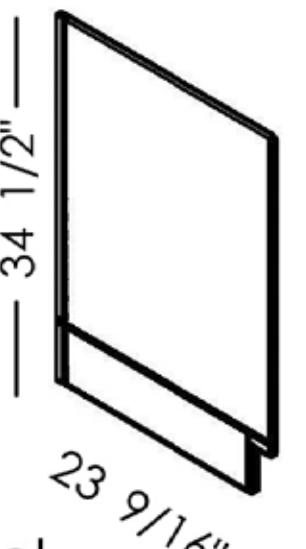
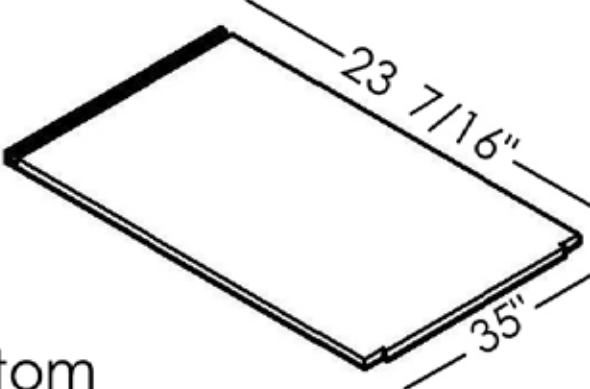
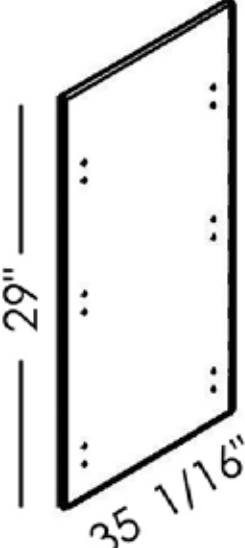
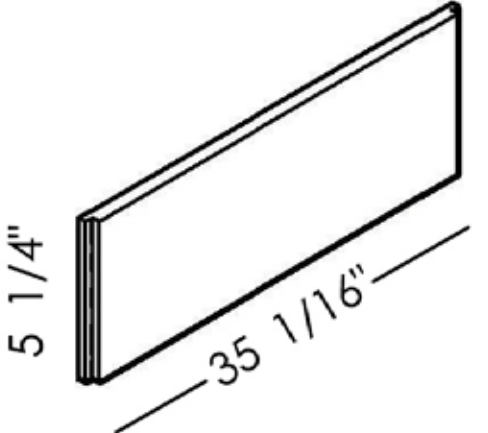
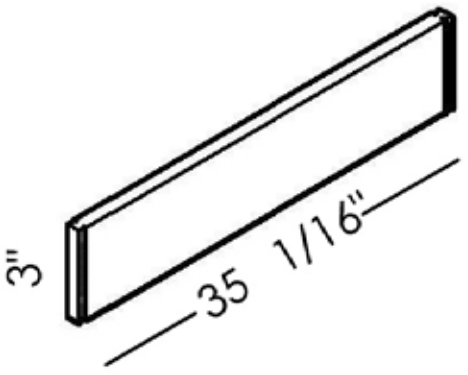
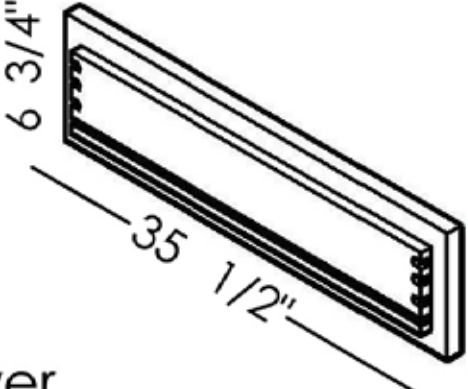
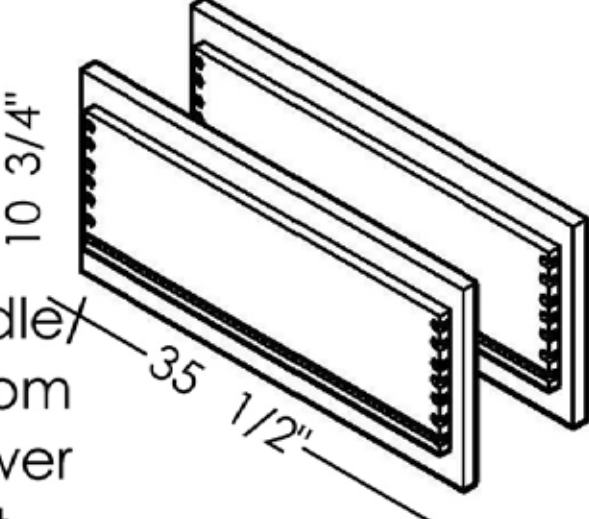
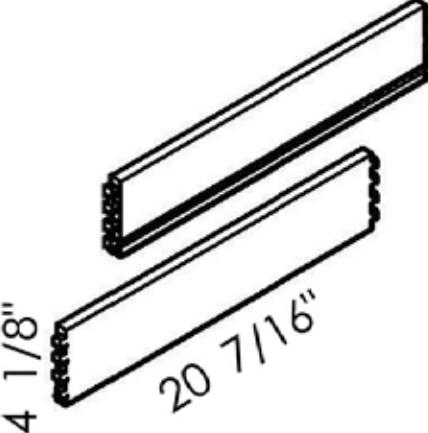
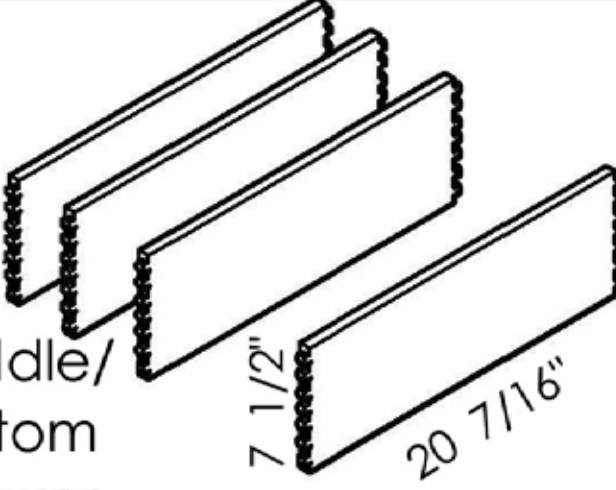
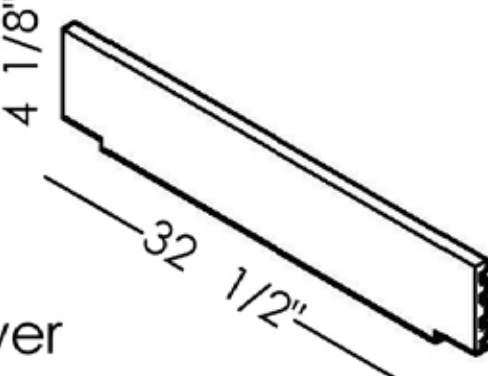
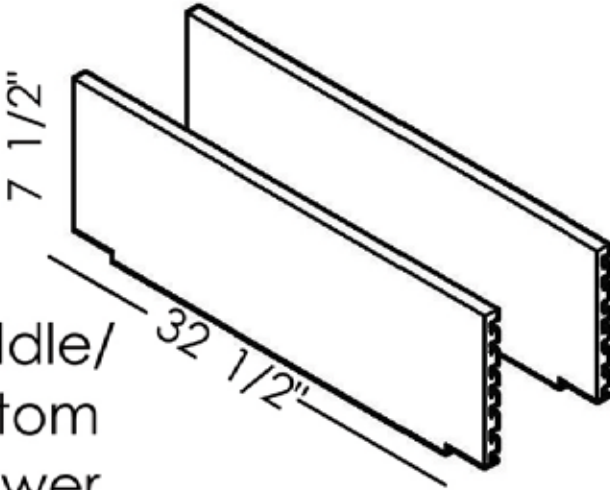
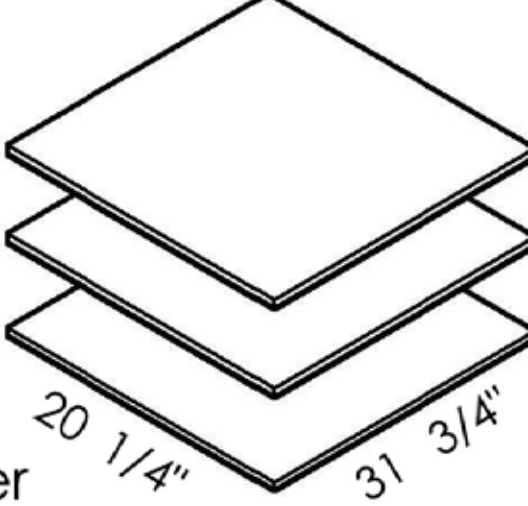

DB36-3

Unit: inch

No	Picture	Specification	Qty
A		Screw $\varnothing 3 \times 1/2$ "	62
B		L Bracket	6
C		Drawer Glides	6
D		Glide Connector	6
E		Corner Bracket	4
F		Metal Clip	4
G		Bumper	12

<p>1</p>  <p>Face Frame</p>	<p>2</p>  <p>Left Side Panel</p>	<p>3</p>  <p>Right Side Panel</p>		
<p>4</p>  <p>Bottom Panel</p>	<p>5</p>  <p>Back Panel</p>	<p>6</p>  <p>Front Toe kick</p>		
<p>7</p>  <p>Back Toe kick</p>	<p>8</p>  <p>Top Drawer Front</p>	<p>9</p>  <p>Middle/Bottom Drawer Front</p>	<p>10</p>  <p>Top Drawer Sides</p>	<p>11</p>  <p>Middle/Bottom Drawer Sides</p>
<p>12</p>  <p>Drawer Back</p>	<p>13</p>  <p>Middle/Bottom Drawer Back</p>	<p>14</p>  <p>Drawer Bottom</p>		

Assembly instructions

No	Picture	Specification	Qty	No	Picture	Specification	Qty
A		Screw $\varnothing 3 \times 1/2''$	62	E		Corner Bracket	4
B		L Bracket	6	F		Metal Clip	4
C		Drawer Glides	6	G		Bumper	12
D		Glide Connector	6				

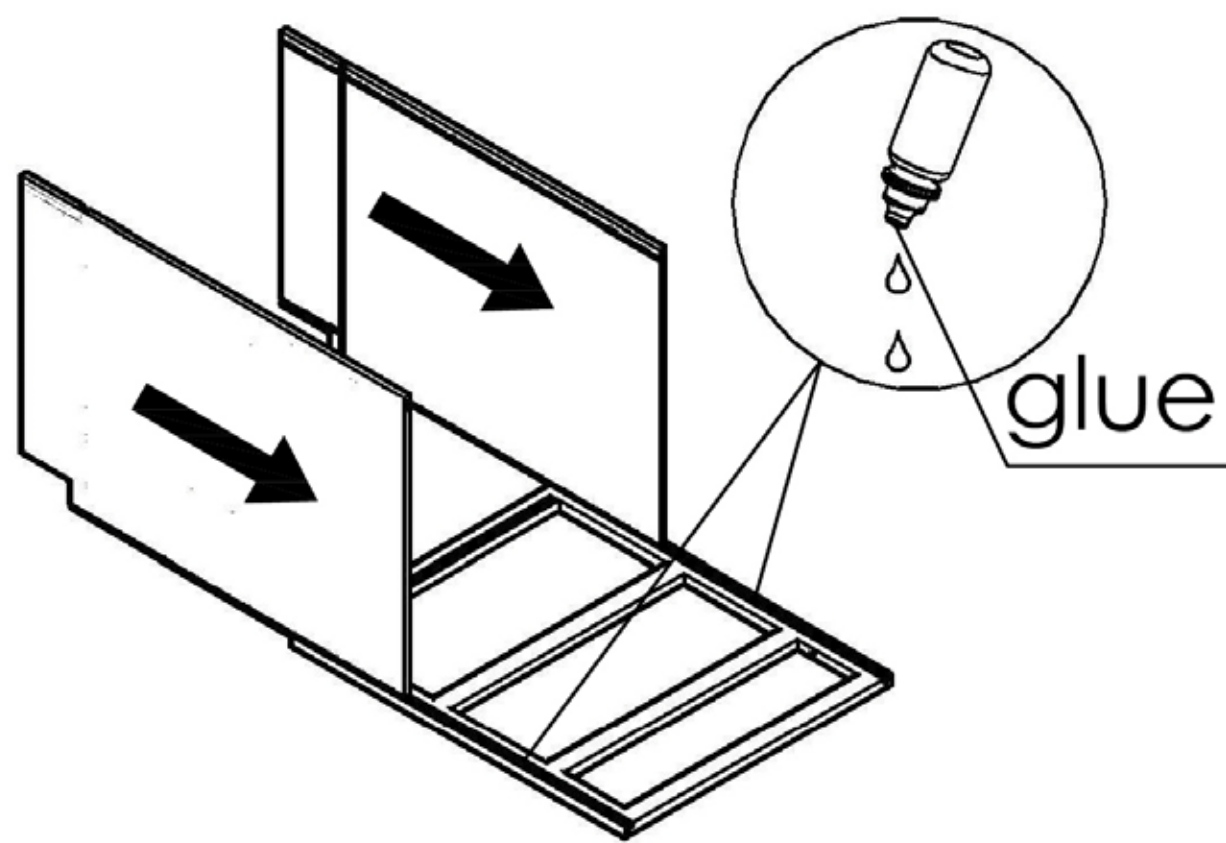

step 1

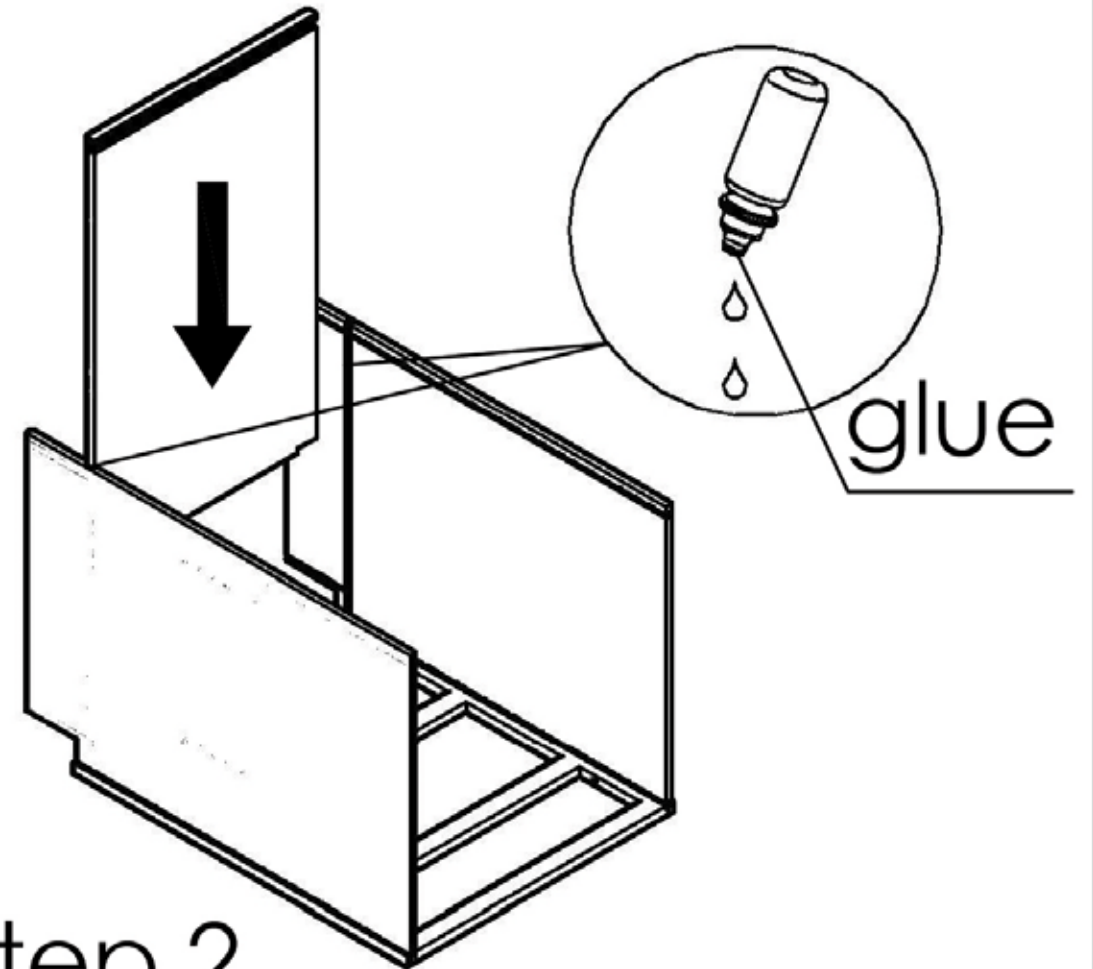

step 2

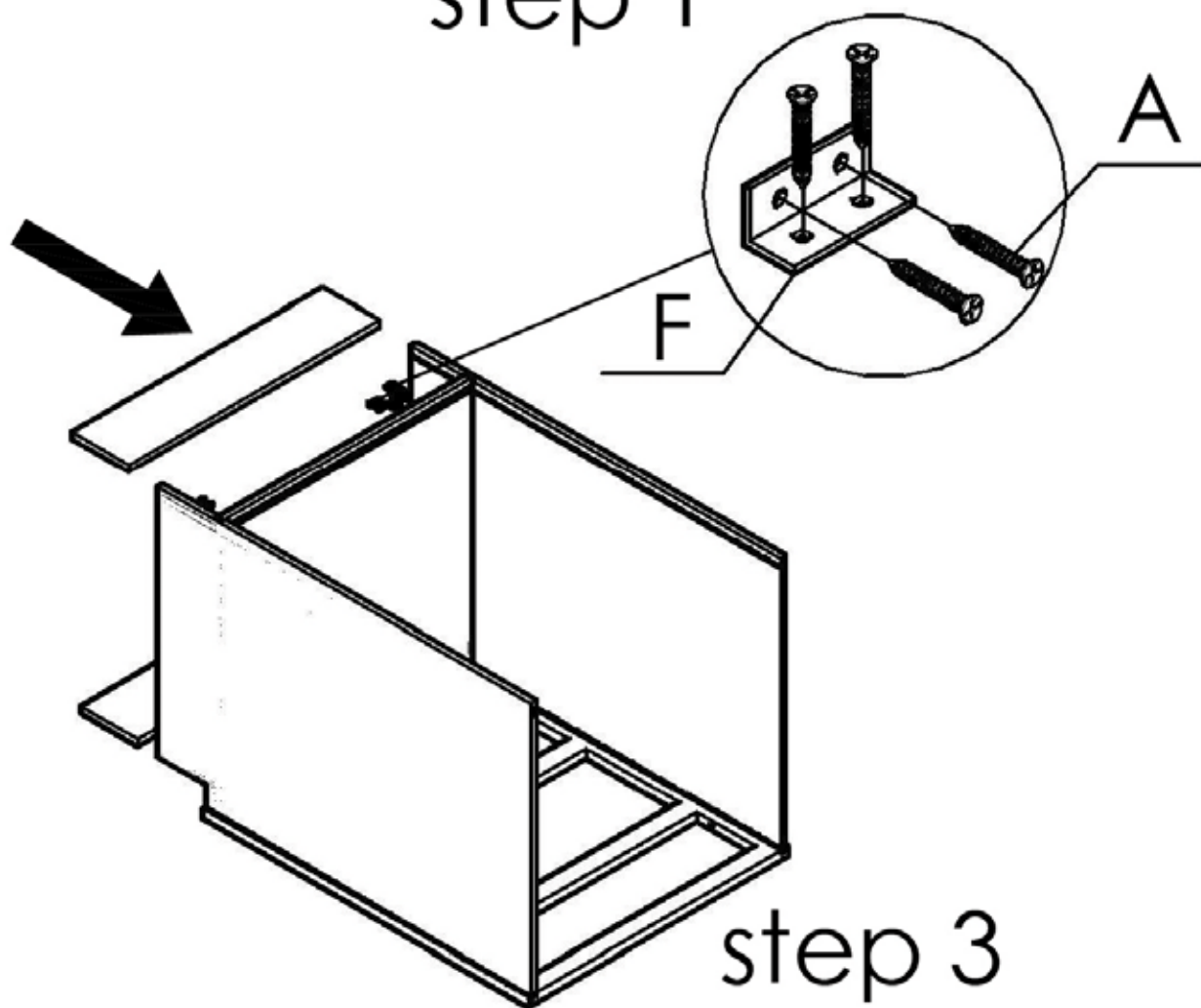

step 3

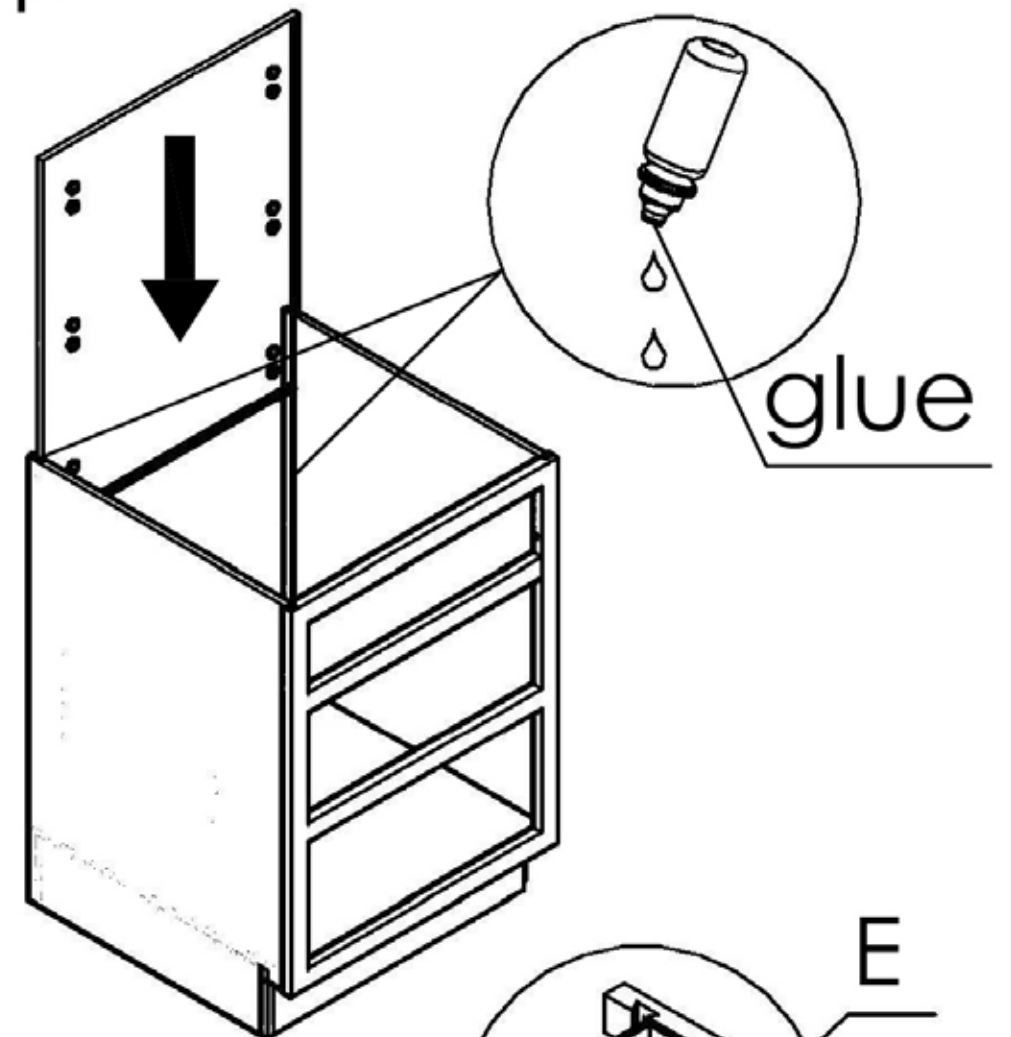

step 4

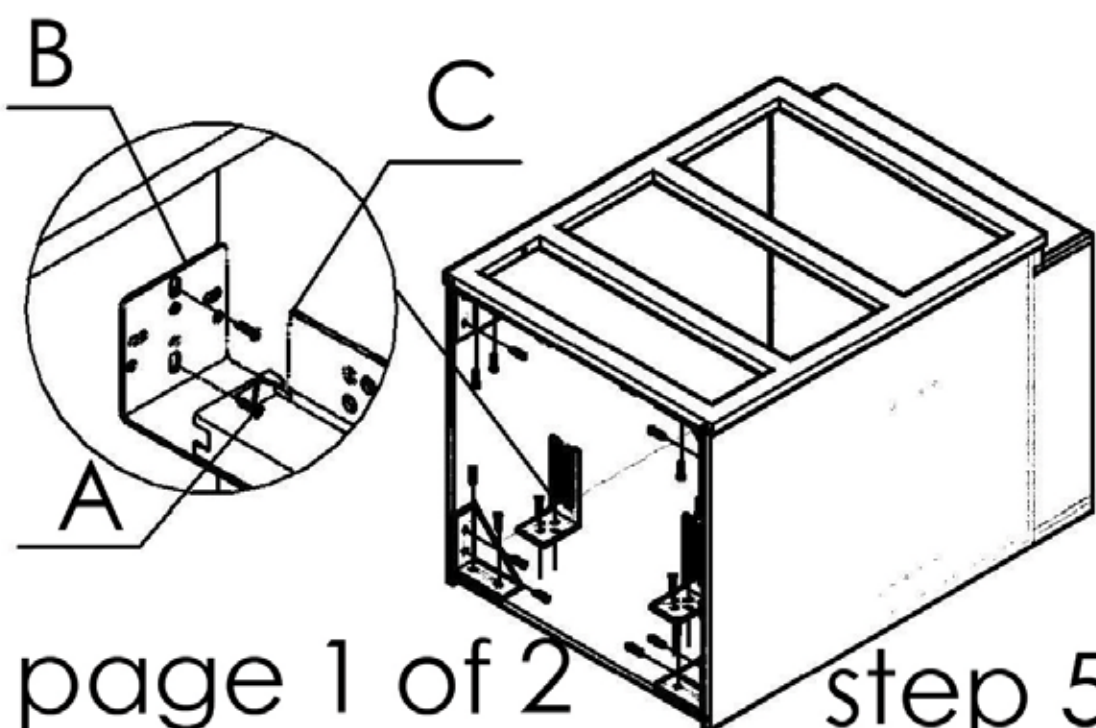

step 5

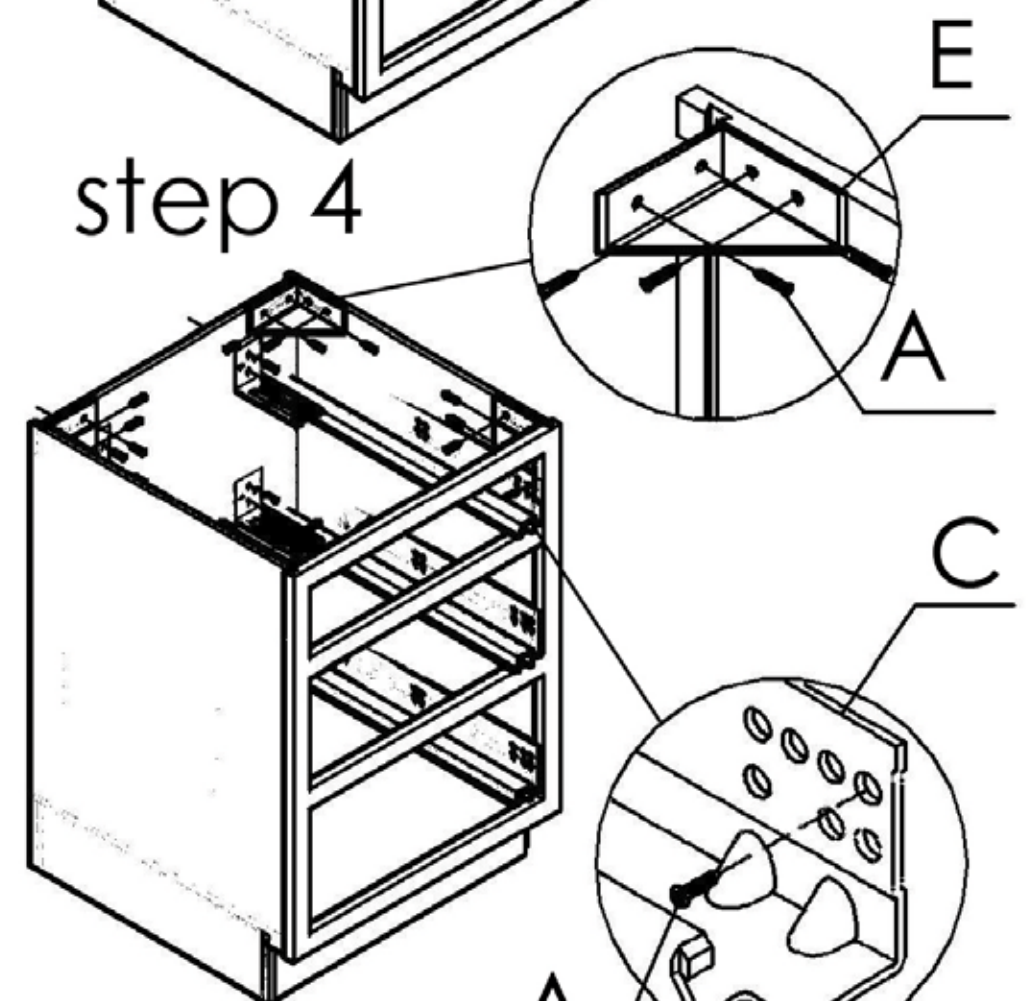

step 6

